



Series 87

DESCRIPCIÓN: Accesorios de latón roscado
DESCRIPTION: Brass threaded fittings

REVISIÓN / UPDATE 17: 10/03/2022 · Pag. 1/13

Hoja Técnica / Technical data sheet

■ APLICACIONES:

El accesorio de latón roscado se usan para unir válvulas u otros accesorios.

■ UTILIZACIÓN:

Uso en agua fría, agua caliente y aire comprimido.
Es compatible con tuberías de cobre y plásticas (PE, PEX, PP, Pb).

■ MATERIALES

Cuerpo en latón.
Latón según norma UNE EN 12165:2011

■ MÉTODO DE FABRICACIÓN

Estampado en caliente.

■ LÍMITES TÉCNICOS:

Rango temperatura trabajo:
Figuras sin juntas: -20° C a 150° C
Figuras con juntas: -20° C a 80° C
Presión nominal:
PN 25: ¼" – ¾"
PN 16: 1" – 4"

■ CARACTERÍSTICAS:

Fabricado según EN 1254-4
Roscas de unión de acuerdo con ISO 228-1
Rosca macho paralela.
Rosca hembra paralela.

■ APPLICATIONS:

Thread brass fitting used to join valves or other fitting.

■ USE:

It is used for cold and hot water, and pressured air.
Compatible to Cuprum and plastic pipes (PE, PEX, PP, Pb).

■ COMPONENTS:

Brass body.
Brass according UNE EN 12165:2011

■ PRODUCTION METHOD:

Hot forged.

■ TECHNICAL LIMITS:

Working temperature range:
Fittings without joints: -20° C to 150° C
Fittings with joints: -20° C to 80° C
Nominal pressure:
PN 25: ¼" – ¾"
PN 16: 1" – 4"

■ FEATURES:

Manufactured according EN1254-4
Connection threads according to ISO 228-1
Parallel Male threads .
Parallel Female threads.

MT Business Key, S.L. se reserva el derecho de modificar en parte o en su totalidad las características de sus productos sin previo aviso.
MT Business Key, S.L. keeps the right to modify in part or totally the characteristics of its products without previous notice.



Para prevenir roturas, accidentes o daños severos, NO USAR este producto fuera de los límites técnicos y sus aplicaciones. Las normas locales pueden regular el uso de este producto.

To avoid abnormal operation, accidents or serious injury, DO NOT use this product outside of the specification range. Local regulations may regulate the use of this product.

87001



Curva 90° M-H
M-F Long sweep bend 90°

87002



Curva 90° H-H
F-F Long sweep bend 90°

87090



Codo 90° H/H
F-F Elbow 90°

87090R



Codo 90° reducido H/H
F-F Reducing elbow 90°

87092



Codo 90° M-H
M-F Elbow 90°

87093



Codo 90° M-M
M-M Elbow 90°

87098



Codo 90° M-H con conector 2 piezas
M-F Elbow 90° with 2 pieces connector

87130



Te igual H
F Equal tee

87130R



Te reducida H
F Reducing tee

87132



Te igual M
M Equal tee

87180



Cruz H
F Cross

87240



Manguito reducción H-H
F-F Reducing socket

87241



Tuerca reducción M-H
M-F Reducing bushing

87245



Machón reducido M-M
M-M Reducing nipple

87246



Manguito reducción M-H
M-F Reducing nipple socket

87270



Manguito H-H
F-F Socket

MT Business Key, S.L. se reserva el derecho de modificar en parte o en su totalidad las características de sus productos sin previo aviso.
MT Business Key, S.L. keeps the right to modify in part or totally the characteristics of its products without previous notice.



Para prevenir roturas, accidentes o daños severos, NO USAR este producto fuera de los límites técnicos y sus aplicaciones. Las normas locales pueden regular el uso de este producto.

To avoid abnormal operation, accidents or serious injury, DO NOT use this product outside of the specification range. Local regulations may regulate the use of this product.

87280



Machón M-M
M-M Hexagon nipple

87290



Tapón M con reborde
M Plug beaded

87300



Tapón hexagonal H
F Hexagon cap

87315



Entronque manguera
Hexagon hose nipple

87318



Te 5 vías
5 way tee

87340



Tuerca unión asiento cónico
H-H
F-F Straight union tapered seat

87341



Tuerca unión asiento cónico
M-H
M-F Straight union tapered seat

873412



Tuerca unión asiento cónico con
junta tórica de NBR M-H
M-F Straight union tapered seat with NBR O-Ring

87500



Codo mural H-H
F-F Wall plated elbow

87529



Manguito igual M-H
M-F Equal socket

87530



Manguito igual M-H (Hexágono
interior)
M-F Equal socket (Hexagon inside)

87531



Manguito igual M/H (Hexágono
interior)
M-F Equal socket (Hexagon inside)

87532



Manguito igual M-H
M-F Equal socket

87533



Alargadera acabado latón M-H
(Hexágono interior)
M-F Extension fitting brass finish (Hexagon inside)

87550



Racor depósito con tuerca
corredera
Tank outlet connection

87551



Tuerca corredera
Back nut

MT Business Key, S.L. se reserva el derecho de modificar en parte o en su totalidad las características de sus productos sin previo aviso.
MT Business Key, S.L. keeps the right to modify in part or totally the characteristics of its products without previous notice.



Para prevenir roturas, accidentes o daños severos, NO USAR este producto fuera de los límites técnicos y sus aplicaciones. Las normas locales pueden regular el uso de este producto.

To avoid abnormal operation, accidents or serious injury, DO NOT use this product outside of the specification range. Local regulations may regulate the use of this product.

87563



Racor hembra dos piezas
manguera H
F Two pieces hose nipple

87575



Anillo reducido M-H
M-F Reducing ring

97001



Junta rácor depósito
*Tank outlet connection
gasket*

MT Business Key, S.L. se reserva el derecho de modificar en parte o en su totalidad las características de sus productos sin previo aviso.
MT Business Key, S.L. keeps the right to modify in part or totally the characteristics of its products without previous notice.



Para prevenir roturas, accidentes o daños severos, NO USAR este producto fuera de los límites técnicos y sus aplicaciones. Las normas locales pueden regular el uso de este producto.

To avoid abnormal operation, accidents or serious injury, DO NOT use this product outside of the specification range. Local regulations may regulate the use of this product.

87001

Curva 90° M-H
M-F Long sweep bend 90°

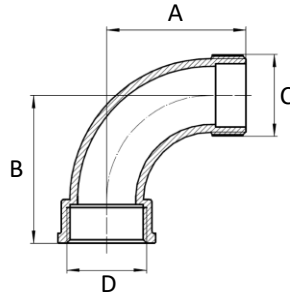

CÓDIGO CODE	MEDIDA SIZE			A	B	C	D
87001-015	1/2"	120	10	38,5	42	1/2"	1/2"
87001-020	3/4"	70	10	43,5	47	3/4"	3/4"
87001-025	1"	40	5	57,5	61	1"	1"
87001-032	1 1/4"	20	5	68,5	72	1 1/4"	1 1/4"
87001-040	1 1/2"	10	5	78	83	1 1/2"	1 1/2"
87001-050	2"	17	1	92	99	2"	2"

87002

Curva 90° H-H
F-F Long sweep bend 90°

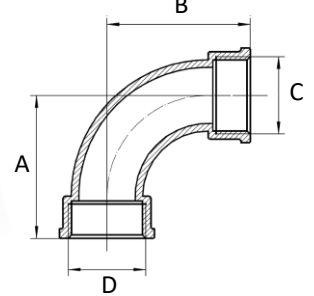

CÓDIGO CODE	MEDIDA SIZE			A	B	C	D
87002-015	1/2"	120	10	42	42	1/2"	1/2"
87002-020	3/4"	70	10	47	47	3/4"	3/4"
87002-025	1"	40	5	61	61	1"	1"
87002-032	1 1/4"	20	5	72	72	1 1/4"	1 1/4"
87002-040	1 1/2"	10	5	83	83	1 1/2"	1 1/2"
87002-050	2"	17	1	99	99	2"	2"

87090

Codo 90° H/H
F-F Elbow 90°

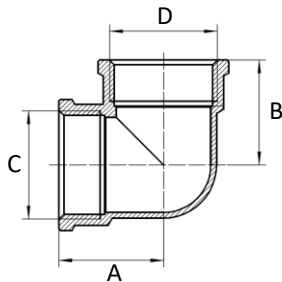

CÓDIGO CODE	MEDIDA SIZE			A	B	C	D
87090-010	3/8"	340	10	17,5	17,5	3/8"	3/8"
87090-015	1/2"	180	10	22	22	1/2"	1/2"
87090-020	3/4"	110	10	28	28	3/4"	3/4"
87090-025	1"	60	5	32	32	1"	1"
87090-032	1 1/4"	35	5	38	38	1 1/4"	1 1/4"
87090-040	1 1/2"	30	5	40,5	40,5	1 1/2"	1 1/2"
87090-050	2"	36	1	51	51	2"	2"
87090-065	2 1/2"	16	1	67	67	2 1/2"	2 1/2"
87090-080	3"	12	1	77	77	3"	3"
87090-100	4"	4	1	95	95	4"	4"

87090R

Codo 90° reducido H/H
F-F Reducing elbow 90°

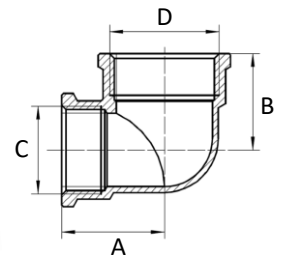

CÓDIGO CODE	MEDIDA SIZE			A	B	C	D
87090-01510	1/2"x3/8"	230	10	20	21	3/8"	1/2"
87090-02015	3/4"x1/2"	130	10	24	24,5	1/2"	3/4"
87090-02515	1"x1/2"	100	5	27	26,5	1/2"	1"
87090-02520	1"x3/4"	75	5	31	29	3/4"	1"
87090-03225	1 1/4"x1"	50	5	34,5	33	1"	1 1/4"
87090-04025	1 1/2"x1"	40	5	36,5	34	1"	1 1/2"
87090-04032	1 1/2" x 1 1/4"	30	5	41	37	1 1/4"	1 1/2"

MT Business Key, S.L. se reserva el derecho de modificar en parte o en su totalidad las características de sus productos sin previo aviso.
MT Business Key, S.L. keeps the right to modify in part or totally the characteristics of its products without previous notice.



Para prevenir roturas, accidentes o daños severos, NO USAR este producto fuera de los límites técnicos y sus aplicaciones. Las normas locales pueden regular el uso de este producto.

To avoid abnormal operation, accidents or serious injury, DO NOT use this product outside of the specification range. Local regulations may regulate the use of this product.

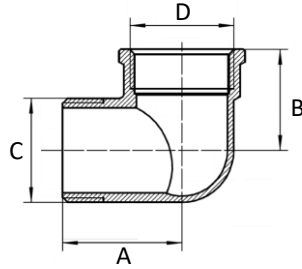
87092Codo 90° M-H
M-F Elbow 90°

CÓDIGO CODE	MEDIDA SIZE			A	B	C	D
87092-010	3/8"	280	10	24,5	17	3/8"	3/8"
87092-015	1/2"	200	10	29	22	1/2"	1/2"
87092-020	3/4"	100	10	33,5	28	3/4"	3/4"
87092-025	1"	60	5	38	32	1"	1"
87092-032	1 1/4"	35	5	45	37	1 1/4"	1 1/4"
87092-040	1 1/2"	25	5	48	40	1 1/2"	1 1/2"
87092-050	2"	32	1	62	52	2"	2"
87092-065	2 1/2"	17	1	77	67	2 1/2"	2 1/2"
87092-080	3"	12	1	86,5	77	3"	3"

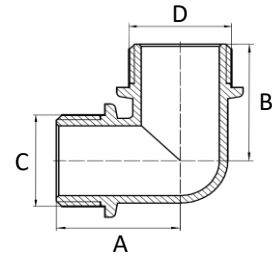
87093Codo 90° M-M
M-M Elbow 90°

CÓDIGO CODE	MEDIDA SIZE			A	B	C	D
87093-010	3/8"	250	10	30	30	3/8"	3/8"
87093-015	1/2"	240	10	27	27	1/2"	1/2"
87093-020	3/4"	120	10	32	32	3/4"	3/4"

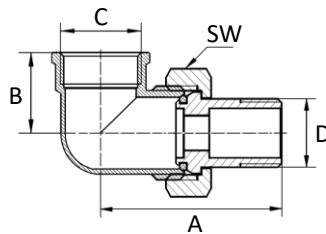
87098Codo 90° M-H con conector 2 piezas
M-F Elbow 90° with 2 pieces connector

Junta tórica NBR / NBR O-Ring

CÓDIGO CODE	MEDIDA SIZE			A	B	C	D	SW
87098-015	1/2"	100	10	44,5	21	1/2"	1/2"	30
87098-020	3/4"	60	10	52	26	3/4"	3/4"	37
87098-025	1"	30	5	60	32	1"	1"	45,5

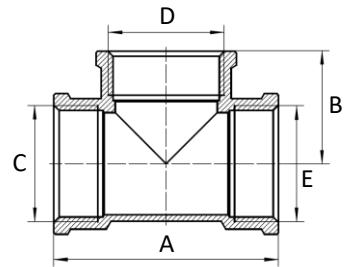
87130Te igual H
F Equal tee

CÓDIGO CODE	MEDIDA SIZE			A	B	C=D=E
87130-010	3/8"	150	10	35	17,5	3/8"
87130-015	1/2"	120	10	44	22	1/2"
87130-020	3/4"	60	10	56	28	3/4"
87130-025	1"	45	5	64	32	1"
87130-032	1 1/4"	25	5	76	38	1 1/4"
87130-040	1 1/2"	20	5	81	40,5	1 1/2"
87130-050	2"	26	1	102	51	2"
87130-065	2 1/2"	12	1	134	67	2 1/2"
87130-080	3"	6	1	154	77	3"
87130-100	4"	4	1	190	95	4"

MT Business Key, S.L. se reserva el derecho de modificar en parte o en su totalidad las características de sus productos sin previo aviso.
MT Business Key, S.L. keeps the right to modify in part or totally the characteristics of its products without previous notice.



Para prevenir roturas, accidentes o daños severos, NO USAR este producto fuera de los límites técnicos y sus aplicaciones. Las normas locales pueden regular el uso de este producto.

To avoid abnormal operation, accidents or serious injury, DO NOT use this product outside of the specification range. Local regulations may regulate the use of this product.



87130R

Te reducida H
F Reducing tee

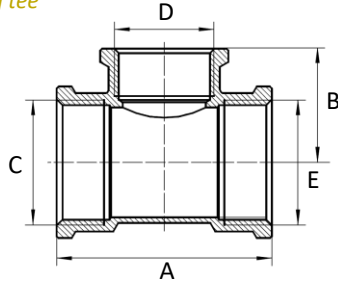

CÓDIGO CODE	MEDIDA SIZE			A	B	C=E	D
87130-01510	1/2" x 3/8"	130	10	42	20	1/2"	3/8"
87130-02015	3/4" x 1/2"	90	10	48	25	3/4"	1/2"
87130-02515	1" x 1/2"	60	5	52	27,5	1"	1/2"
87130-02520	1" x 3/4"	50	5	57	30	1"	3/4"
87130-03215	1 1/4"x1/2"	40	5	56	32	1 1/4"	1/2"
87130-03220	1 1/4"x3/4"	30	5	61	34	1 1/4"	3/4"
87130-03225	1 1/4" x1"	30	5	66	34,5	1 1/4"	1"
87130-04015	1 1/2"x1/2"	25	5	59	34,5	1 1/2"	1/2"
87130-04020	1 1/2"x3/4"	25	5	63	37	1 1/2"	3/4"
87130-04025	1 1/2"x1"	25	5	66	38	1 1/2"	1"
87130-04032	1 1/2"x1 1/4"	20	5	74	41	1 1/2"	1 1/4"
87130-05015	2" x 1/2"	42	1	66	44	2"	1/2"
87130-05020	2" x 3/4"	42	1	69	44	2"	3/4"
87130-05025	2" x 1"	42	1	78	44	2"	1"
87130-05032	2" x 1 1/4"	36	1	85	46	2"	1 1/4"

87132

Te igual M
M Equal tee

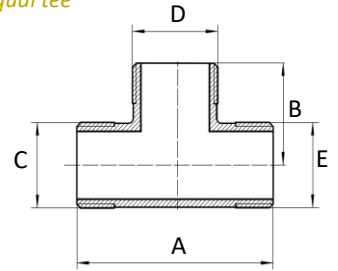

CÓDIGO CODE	MEDIDA SIZE			A	B	C=D=E
87132-015	1/2"	200	10	46	23	1/2"
87132-020	3/4"	90	10	57	29,5	3/4"

87180

Cruz H
F Cross

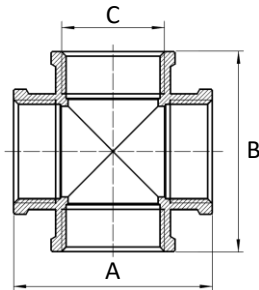

CÓDIGO CODE	MEDIDA SIZE			A	B	C
87180-010	3/8"	200	10	35	35	3/8"
87180-015	1/2"	110	10	44	44	1/2"
87180-020	3/4"	60	10	56	56	3/4"
87180-025	1"	35	5	64	64	1"
87180-032	1 1/4"	20	5	76	76	1 1/4"
87180-040	1 1/2"	15	5	81	81	1 1/2"
87180-050	2"	18	1	102	102	2"

87240

Manguito reducción H-H
F-F Reducing socket

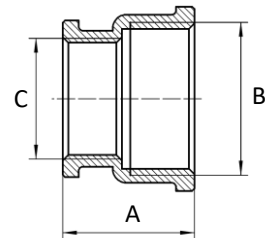

CÓDIGO CODE	MEDIDA SIZE			A	B	C
87240-01510	1/2" x 3/8"	300	10	21,5	1/2"	3/8"
87240-02010	3/4" x 3/8"	250	10	23,5	3/4"	3/8"
87240-02015	3/4" x 1/2"	210	10	26	3/4"	1/2"
87240-02515	1" x 1/2"	160	5	28	1"	1/2"
87240-02520	1" x 3/4"	150	5	29	1"	3/4"
87240-03225	1 1/4" x 1"	90	5	33	1 1/4"	1"
87240-04025	1 1/2" x 1"	70	5	33	1 1/2"	1"
87240-04032	1 1/2" x 1 1/4"	60	5	35	1 1/2"	1 1/4"
87240-05025	2" x 1"	76	1	37	2"	1"
87240-05032	2" x 1 1/4"	76	1	39	2"	1 1/4"
87240-05040	2" x 1 1/2"	76	1	40	2"	1 1/2"

MT Business Key, S.L. se reserva el derecho de modificar en parte o en su totalidad las características de sus productos sin previo aviso.
MT Business Key, S.L. keeps the right to modify in part or totally the characteristics of its products without previous notice.



Para prevenir roturas, accidentes o daños severos, NO USAR este producto fuera de los límites técnicos y sus aplicaciones. Las normas locales pueden regular el uso de este producto.

To avoid abnormal operation, accidents or serious injury, DO NOT use this product outside of the specification range. Local regulations may regulate the use of this product.

87245

Machón reducido M-M
M-M Reducing nipple

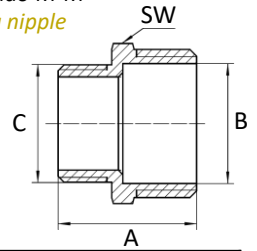

87241

Tuerca reducción M-H
M-F Reducing bushing

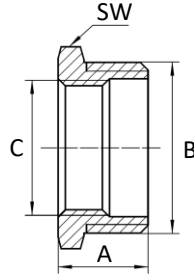

CÓDIGO CODE	MEDIDA SIZE			A	B	C	SW
87245-01008	3/8" x 1/4"	600	10	21	3/8"	1/4"	18
87245-01508	1/2" x 1/4"	400	10	23	1/2"	1/4"	21
87245-01510	1/2" x 3/8"	500	10	24,5	1/2"	3/8"	21
87245-02010	3/4" x 3/8"	280	10	26,5	3/4"	3/8"	26,5
87245-02015	3/4" x 1/2"	270	10	29	3/4"	1/2"	26,5
87245-02515	1" x 1/2"	160	5	30	1"	1/2"	33,5
87245-02520	1" x 3/4"	150	5	31	1"	3/4"	33,5
87245-03220	1 1/4" x 3/4"	100	5	34,5	1 1/4"	3/4"	42
87245-03225	1 1/4" x 1"	95	5	35	1 1/4"	1"	42
87245-04025	1 1/2" x 1"	80	5	35	1 1/2"	1"	48,5
87245-04032	1 1/2" x 1 1/4"	70	5	38	1 1/2"	1 1/4"	48,5
87245-05025	2" x 1"	120	1	40	2"	1"	60
87245-05032	2" x 1 1/4"	120	1	42	2"	1 1/4"	60
87245-05040	2" x 1 1/2"	96	1	42,5	2"	1 1/2"	60

CÓDIGO CODE	MEDIDA SIZE			A	B	C	SW
87241-01008	3/8" x 1/4"	800	10	13	3/8"	1/4"	17
87241-01506	1/2" x 1/8"	600	10	14,5	1/2"	1/8"	22
87241-01508	1/2" x 1/4"	500	10	14,5	1/2"	1/4"	21
87241-01510	1/2" x 3/8"	500	10	14,5	1/2"	3/8"	21
87241-02010	3/4" x 3/8"	400	10	15	3/4"	3/8"	27
87241-02015	3/4" x 1/2"	300	10	16	3/4"	1/2"	26,5
87241-02515	1" x 1/2"	200	5	17,5	1"	1/2"	35
87241-02520	1" x 3/4"	200	5	17,5	1"	3/4"	35
87241-03220	1 1/4" x 3/4"	140	5	19,5	1 1/4"	3/4"	42
87241-03225	1 1/4" x 1"	140	5	19,5	1 1/4"	1"	42
87241-04025	1 1/2" x 1"	115	5	20,5	1 1/2"	1"	48,5
87241-04032	1 1/2" x 1 1/4"	115	5	20,5	1 1/2"	1 1/4"	48,5
87241-05025	2" x 1"	140	1	25,5	2"	1"	60
87241-05032	2" x 1 1/4"	140	1	25,5	2"	1 1/4"	60
87241-05040	2" x 1 1/2"	120	1	25,5	2"	1 1/2"	60
87241-06532	2 1/2" x 1 1/4"	90	1	28	2 1/2"	1 1/4"	76,5
87241-06540	2 1/2" x 1 1/2"	90	1	28	2 1/2"	1 1/2"	76,5
87241-06550	2 1/2" x 2"	90	1	28	2 1/2"	2"	76,5
87241-08050	3" x 2"	56	1	33	3"	2"	89,5
87241-08065	3" x 2 1/2"	56	1	33	3"	2 1/2"	89,5
87241-10050	4" x 2"	26	1	44	4"	2"	115
87241-10065	4" x 2 1/2"	26	1	44	4"	2 1/2"	115
87241-10080	4" x 3"	26	1	44	4"	3"	115

87246

Manguito reducción M-H
M-F Reducing nipple socket

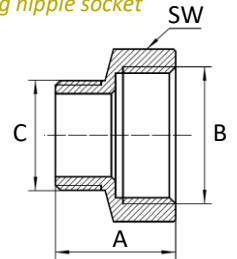

CÓDIGO CODE	MEDIDA SIZE			A	B	C	SW
87246-00810	1/4" x 3/8"	500	10	20	3/8"	1/4"	20
87246-01008	3/8" x 1/4"	750	10	19	1/4"	3/8"	17
87246-01015	3/8" x 1/2"	400	10	21,5	1/2"	3/8"	25
87246-01020	3/8" x 3/4"	180	10	23	3/4"	3/8"	30,5
87246-01510	1/2" x 3/8"	500	10	21,5	3/8"	1/2"	21
87246-01520	1/2" x 3/4"	280	10	25	3/4"	1/2"	30
87246-01525	1/2" x 1"	180	10	28	1"	1/2"	37
87246-02015	3/4" x 1/2"	280	10	24	1/2"	3/4"	26,5
87246-02025	3/4" x 1"	160	10	29	1"	3/4"	37
87246-02520	1" x 3/4"	150	5	27	3/4"	1"	33,5
87246-02532	1" x 1 1/4"	105	5	32	1 1/4"	1"	47
87246-02540	1" x 1 1/2"	75	5	34	1 1/2"	1"	52
87246-02550	1" x 2"	115	5	38	2"	1"	64
87246-03240	1 1/4" x 1 1/2"	70	5	36	1 1/2"	1 1/4"	52
87246-03250	1 1/4" x 2"	110	5	40	2"	1 1/4"	64
87246-04050	1 1/2" x 2"	110	5	40,5	2"	1 1/2"	64

MT Business Key, S.L. se reserva el derecho de modificar en parte o en su totalidad las características de sus productos sin previo aviso.
MT Business Key, S.L. keeps the right to modify in part or totally the characteristics of its products without previous notice.



Para prevenir roturas, accidentes o daños severos, NO USAR este producto fuera de los límites técnicos y sus aplicaciones. Las normas locales pueden regular el uso de este producto.

To avoid abnormal operation, accidents or serious injury, DO NOT use this product outside of the specification range. Local regulations may regulate the use of this product.



Management System
ISO 9001:2015

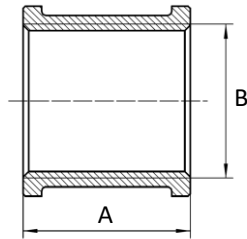
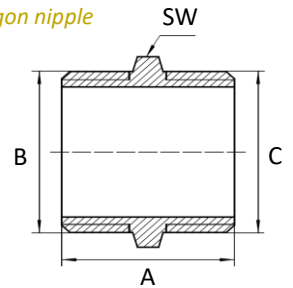

www.tuv.com
ID: 9108643013

87270Manguito H-H
F-F Socket**87280**Machón M-M
M-M Hexagon nipple

CÓDIGO CODE	MEDIDA SIZE			A	B
87270-010	3/8"	400	10	25	3/8"
87270-015	1/2"	230	10	30	1/2"
87270-020	3/4"	140	10	34	3/4"
87270-025	1"	100	10	36	1"
87270-032	1 1/4"	55	5	43	1 1/4"
87270-040	1 1/2"	35	5	53	1 1/2"
87270-050	2"	45	1	65	2"
87270-065	2 1/2"	30	1	68	2 1/2"
87270-080	3"	21	1	70	3"
87270-100	4"	12	1	80	4"

CÓDIGO CODE	MEDIDA SIZE			A	B	C	SW
87280-008	1/4"	800	10	21	1/4"	1/4"	13
87280-010	3/8"	500	10	22,5	3/8"	3/8"	18
87280-015	1/2"	300	10	25,5	1/2"	1/2"	23
87280-020	3/4"	200	10	29	3/4"	3/4"	28
87280-025	1"	120	5	31,5	1"	1"	35
87280-032	1 1/4"	75	5	35,5	1 1/4"	1 1/4"	44
87280-040	1 1/2"	60	5	39	1 1/2"	1 1/2"	50
87280-050	2"	96	1	45	2"	2"	62
87280-065	2 1/2"	45	1	58	2 1/2"	2 1/2"	76,5
87280-080	3"	32	1	63	3"	3"	89,5
87280-100	4"	12	1	81	4"	4"	115

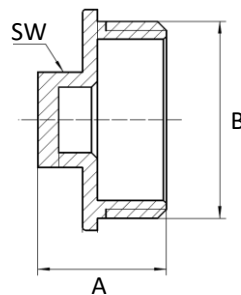
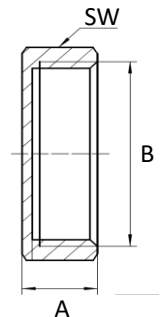
87290Tapón M con reborde
M Plug beaded**87300**Tapón hexagonal H
F Hexagon cap

CÓDIGO CODE	MEDIDA SIZE			A	B	SW
87290-008	1/4"	900	10	13,5	1/4"	10
87290-010	3/8"	600	10	14	3/8"	14
87290-015	1/2"	470	10	17	1/2"	16
87290-020	3/4"	300	10	19,5	3/4"	21
87290-025	1"	200	5	21,5	1"	26
87290-032	1 1/4"	120	5	25,5	1 1/4"	26
87290-040	1 1/2"	110	5	28,5	1 1/2"	32
87290-050	2"	160	1	34,5	2"	37
87290-065	2 1/2"	84	1	39,5	2 1/2"	48
87290-080	3"	56	1	46,5	3"	52
87290-100	4"	24	1	55,5	4"	60

CÓDIGO CODE	MEDIDA SIZE			A	B	SW
87300-010	3/8"	600	10	10,5	3/8"	20
87300-015	1/2"	430	10	12	1/2"	24
87300-020	3/4"	300	10	13,5	3/4"	30
87300-025	1"	200	5	15	1"	36,5
87300-032	1 1/4"	150	5	15	1 1/4"	45,5
87300-040	1 1/2"	110	5	16	1 1/2"	52
87300-050	2"	135	1	19	2"	63,5

MT Business Key, S.L. se reserva el derecho de modificar en parte o en su totalidad las características de sus productos sin previo aviso.
 MT Business Key, S.L. keeps the right to modify in part or totally the characteristics of its products without previous notice.



Para prevenir roturas, accidentes o daños severos, NO USAR este producto fuera de los límites técnicos y sus aplicaciones. Las normas locales pueden regular el uso de este producto.

To avoid abnormal operation, accidents or serious injury, DO NOT use this product outside of the specification range. Local regulations may regulate the use of this product.

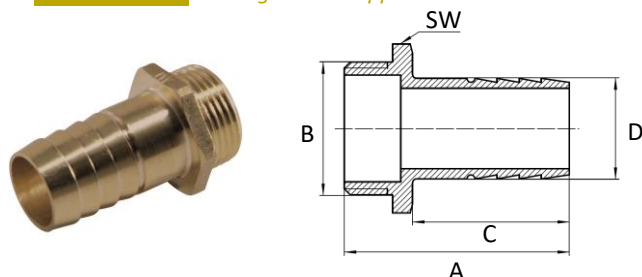

87315Entronque manguera
Hexagon hose nipple

CÓDIGO CODE	MEDIDA SIZE			A	B	C	D	SW
87315-00810	1/4" X 10	400	10	39,5	1/4"	25	10	13,5
87315-00812	1/4" x 12	350	10	42,5	1/4"	28	12	13,5
87315-01012	3/8" x 12	300	10	41	3/8"	28	12	20
87315-01512	1/2" X 12	300	10	43,5	1/2"	28	12	25,5
87315-01514	1/2" x 14	280	10	47	1/2"	32	14	25
87315-01516	1/2" X 16	240	10	49	1/2"	34	16	25,8
87315-01518	1/2" X 18	230	10	49	1/2"	34	18	25,5
87315-01520	1/2" X 20	190	10	53,5	1/2"	38	20	25,5
87315-02020	3/4" x 20	140	10	54	3/4"	38	20	30
87315-02025	3/4" x 25	120	10	55,5	3/4"	39	25	27
87315-02525	1" x 25	100	5	58	1"	40	25	37
87315-02530	1" x 30	80	5	56	1"	39	30	38
87315-03230	1 1/4" x 30	50	5	61,5	1 1/4"	39	30	42,5
87315-03235	1 1/4" x 35	50	5	66	1 1/4"	44	35	49
87315-03238	1 1/4" x 38	40	5	66	1 1/4"	44	38	42,5
87315-03240	1 1/4" x 40	40	5	69	1 1/4"	47	40	49
87315-04038	1 1/2" x 38	30	5	69	1 1/2"	44	38	49
87315-04045	1 1/2" x 45	30	5	76	1 1/2"	50	45	57
87315-04050	1 1/2" x 50	20	5	78	1 1/2"	53	50	57
87315-05060	2" x 60	33	1	88	2"	59	60	68

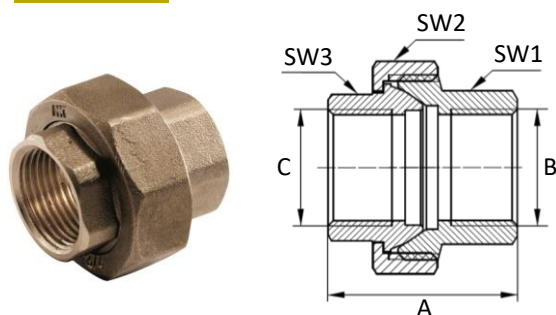
87340Tuerca unión asiento cónico H-H
F-F Straight union tapered seat

CÓDIGO CODE	MEDIDA SIZE			A	B=C	SW1 SW3	SW2
87340-015	1/2"	140	10	34,5	1/2"	24	37
87340-020	3/4"	80	10	40	3/4"	30,5	46
87340-025	1"	60	5	45	1"	37	52
87340-032	1 1/4"	30	5	51,5	1 1/4"	46	64
87340-040	1 1/2"	25	5	56,5	1 1/2"	52	70
87340-050	2"	30	1	68,5	2"	64,5	86,5

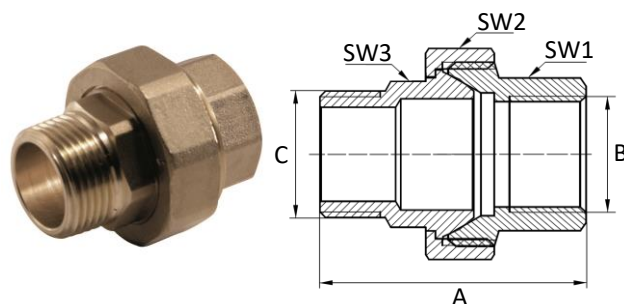
87341Tuerca unión asiento cónico M-H
M-F Straight union tapered seat

CÓDIGO CODE	MEDIDA SIZE			A	B=C	SW1	SW2	SW3
87341-015	1/2"	120	10	46,5	1/2"	24	37	22,5
87341-020	3/4"	70	10	52	3/4"	30,5	46	29
87341-025	1"	45	5	57,5	1"	37	52	34,5
87341-032	1 1/4"	30	5	64,5	1 1/4"	46	64	44
87341-040	1 1/2"	20	5	73,5	1 1/2"	52	70	49
87341-050	2"	24	1	82,5	2"	64,5	86,5	61,5

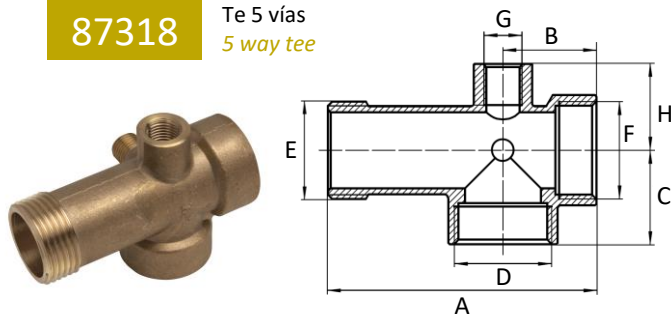
87318Te 5 vías
5 way tee

CÓDIGO CODE	MEDIDA SIZE			A	B=C	D=E=F	G	H
87318-025	1"	30	5	92	32	1"	1/4"	29,4

MT Business Key, S.L. se reserva el derecho de modificar en parte o en su totalidad las características de sus productos sin previo aviso.
 MT Business Key, S.L. keeps the right to modify in part or totally the characteristics of its products without previous notice.



Para prevenir roturas, accidentes o daños severos, NO USAR este producto fuera de los límites técnicos y sus aplicaciones. Las normas locales pueden regular el uso de este producto.

To avoid abnormal operation, accidents or serious injury, DO NOT use this product outside of the specification range. Local regulations may regulate the use of this product.

873412

Tuerca unión asiento cónico con junta tórica de NBR M-H
M-F Straight union tapered seat with NBR O-Ring

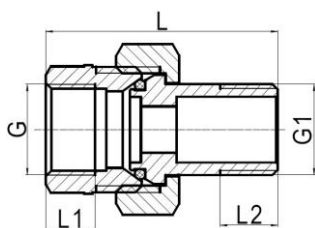

Junta tórica NBR / NBR O-Ring

87500

Codo mural H-H
F-F Wall plated elbow

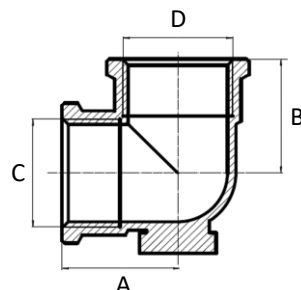

CÓDIGO CODE	MEDIDA SIZE			L	G=G1	L1	L2
873412-015	1/2"	130	10	41,4	1/2"	10,5	10,5
873412-020	3/4"	80	10	46,9	3/4"	12	11
873412-025	1"	50	5	51,8	1"	14	14
873412-032	1 1/4"	30	5	60,5	1 1/4"	15,5	16
873412-040	1 1/2"	20	5	65,1	1 1/2"	17	17
873412-050	2"	12	1	78,8	2"	20	20

CÓDIGO CODE	MEDIDA SIZE			A	B	C	D
87500-015	1/2"	140	10	22	22	1/2"	1/2"

87529

Manguito igual M-H
M-F Equal socket

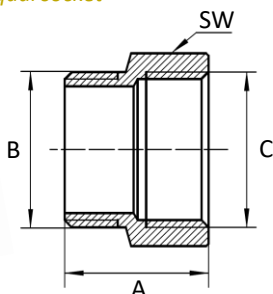

CÓDIGO CODE	MEDIDA SIZE			A	B	C	SW
87529-008	1/4"	800	10	18,5	1/4"	1/4"	17
87529-010	3/8"	500	10	18	3/8"	3/8"	19
87529-015	1/2"	320	10	22,5	1/2"	1/2"	24
87529-020	3/4"	220	10	26,5	3/4"	3/4"	30
87529-025	1"	110	5	30,5	1"	1"	36,5
87529-032	1 1/4"	80	5	33	1 1/4"	1 1/4"	45,5
87529-040	1 1/2"	50	5	35	1 1/2"	1 1/2"	52
87529-050	2"	70	1	42,5	2"	2"	64

87530

Manguito igual M-H (Hexágono interior)
M-F Equal socket (Hexagon inside)

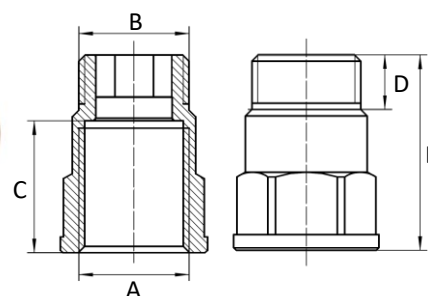

CÓDIGO CODE	MEDIDA SIZE			A	B	C	D	L
87530-1502	1/2" x 2cm	250	10	1/2"	1/2"	25	10,5	37,5

MT Business Key, S.L. se reserva el derecho de modificar en parte o en su totalidad las características de sus productos sin previo aviso.
 MT Business Key, S.L. keeps the right to modify in part or totally the characteristics of its products without previous notice.



Para prevenir roturas, accidentes o daños severos, NO USAR este producto fuera de los límites técnicos y sus aplicaciones. Las normas locales pueden regular el uso de este producto.

To avoid abnormal operation, accidents or serious injury, DO NOT use this product outside of the specification range. Local regulations may regulate the use of this product.

87531Manguito igual M/H (Hexágono interior)
M-F Equal socket (Hexagon inside)

CÓDIGO	MEDIDA			A	B	C	L
CODE	SIZE						
87531-015	1/2" x 1cm	220	10	1/2"	1/2"	13	25,5

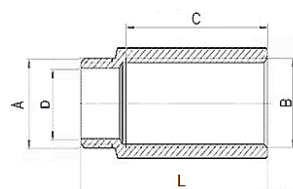
87532Manguito igual M-H
M-F Equal socket

CÓDIGO	MEDIDA			A	B	C	D	L
CODE	SIZE							
87532-01503	1/2" x 3cm	250	10	1/2"	1/2"	28	15,4	40

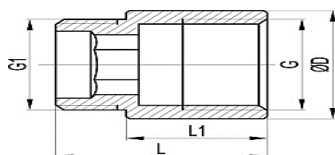
87533Alargadera acabado latón M-H (Hexágono interior)
M-F Extension fitting brass finish (Hexagon inside)

CÓDIGO	MEDIDA			D	G	G1	L	L1
CODE	SIZE							
87533-15020	1/2" x 20	300	10	25	1/2"	1/2"	30	20
87533-15030	1/2" x 30	200	10	25	1/2"	1/2"	40	30
87533-15050	1/2" x 50	130	5	25	1/2"	1/2"	60	50
87533-15100	1/2" x 100	90	5	25	1/2"	1/2"	110	100
87533-20050	3/4" x 50	90	5	30,5	3/4"	3/4"	62	50
87533-20100	3/4" x 100	60	5	30,5	3/4"	3/4"	112	100

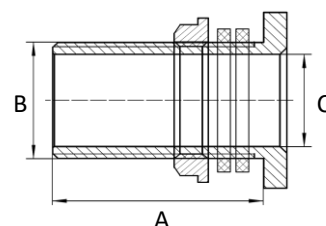
87550Racor depósito con tuerca corredera
Tank outlet connection

CÓDIGO	MEDIDA			A	B	C
CODE	SIZE					
87550-010	3/8"	180	10	44,5	3/8"	12
87550-015	1/2"	120	10	45,5	1/2"	15,5
87550-020	3/4"	80	10	45,5	3/4"	21
87550-025	1"	50	5	48,5	1"	27
87550-032	1 1/4"	30	5	50	1 1/4"	35,5
87550-040	1 1/2"	25	1	58,5	1 1/2"	40
87550-050	2"	30	1	68	2"	51,5
87550-065	2 1/2"	22	1	72,5	2 1/2"	67
87550-080	3"	10	1	90	3"	79

MT Business Key, S.L. se reserva el derecho de modificar en parte o en su totalidad las características de sus productos sin previo aviso.
 MT Business Key, S.L. keeps the right to modify in part or totally the characteristics of its products without previous notice.



Para prevenir roturas, accidentes o daños severos, NO USAR este producto fuera de los límites técnicos y sus aplicaciones. Las normas locales pueden regular el uso de este producto.

To avoid abnormal operation, accidents or serious injury, DO NOT use this product outside of the specification range. Local regulations may regulate the use of this product.

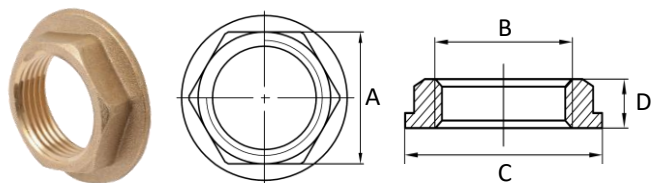
87551Tuerca corredera
Back nut

CÓDIGO <i>CODE</i>	MEDIDA <i>SIZE</i>			A	B	C	D
87551-010	3/8"	1000	10	20	3/8"	26	6
87551-015	1/2"	800	10	24	1/2"	30	6,5
87551-020	3/4"	500	10	30	3/4"	37	6,5
87551-025	1"	350	10	36	1"	43,5	7,5
87551-032	1 1/4"	100	10	45,5	1 1/4"	54,5	8

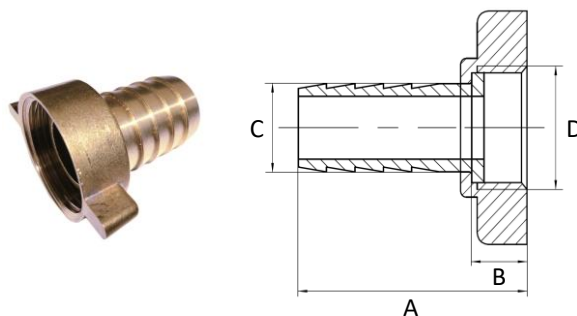
87563Racor hembra dos piezas manguera
Female two pieces hose nipple

CÓDIGO <i>CODE</i>	MEDIDA <i>SIZE</i>			A	B	C	D
87563-01514	1/2" x 14	300	10	38	10	14	1/2"
87563-02020	3/4" x 20	180	10	43	11	20	3/4"
87563-02525	1" x 25	100	5	42	10,5	25	1"
87563-03230	1 1/4" x 30	80	5	49	13	30	1 1/4"
87563-03235	1 1/4" x 35	80	5	51,5	13,6	35	1 1/4"
87563-04040	1 1/2" x 40	50	1	57	14,4	40	1 1/2"

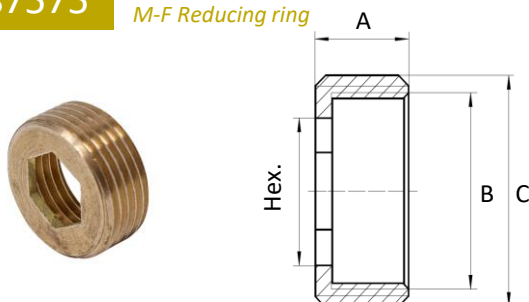
87575Anillo reducido M-H
M-F Reducing ring

CÓDIGO <i>CODE</i>	MEDIDA <i>SIZE</i>			A	B	C	Hex.
87575-01510	1/2" x 3/8"	800	10	10	3/8"	1/2"	10
87575-02015	3/4" x 1/2"	500	10	11	1/2"	3/4"	13

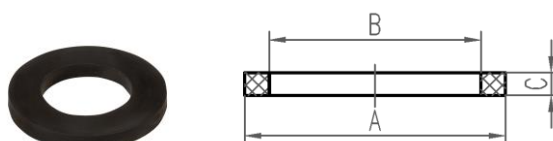
97001Junta racor depósito
Tank outlet connection gasket

CÓDIGO <i>CODE</i>	MEDIDA <i>SIZE</i>			A	B	C
97001-010	3/8"	1200	100	25,5	16,5	2,5
97001-015	1/2"	1000	50	32	21	2,5
97001-020	3/4"	700	50	40	26	3
97001-025	1"	500	20	47	33	3
97001-032	1 1/4"	300	10	59	42	3,5
97001-040	1 1/2"	250	10	68	47,5	3,5
97001-050	2"	200	10	81	59,5	4
97001-065	2 1/2"	150	10	93	75	4
97001-080	3"	90	10	117	87,5	4,5

MT Business Key, S.L. se reserva el derecho de modificar en parte o en su totalidad las características de sus productos sin previo aviso.
 MT Business Key, S.L. keeps the right to modify in part or totally the characteristics of its products without previous notice.



Para prevenir roturas, accidentes o daños severos, NO USAR este producto fuera de los límites técnicos y sus aplicaciones. Las normas locales pueden regular el uso de este producto.

To avoid abnormal operation, accidents or serious injury, DO NOT use this product outside of the specification range. Local regulations may regulate the use of this product.